

Yashica FR I

3-28-02 / 8-13-2019

This camera manual library is for reference
and historical purposes, all rights reserved.

This page is copyright by mike@butkus.org, M. Butkus, NJ.

This page may not be sold or distributed without
the expressed permission of the producer.

On-line camera manual library

If you find this manual useful, how about a donation of \$3 to:

M. Butkus, 29 Lake Ave., High Bridge, NJ 08829

This will help me to continue to host this site,
buy new manuals, and pay their shipping costs.

It'll make you feel better, won't it? If you use Pay Pal, use the link below.

Use the above address for a check, M.O. or cash.



<https://www.PayPal.me/butkus>

Venmo @mike-butkus-camera

[Back to my main camera manual page](#)

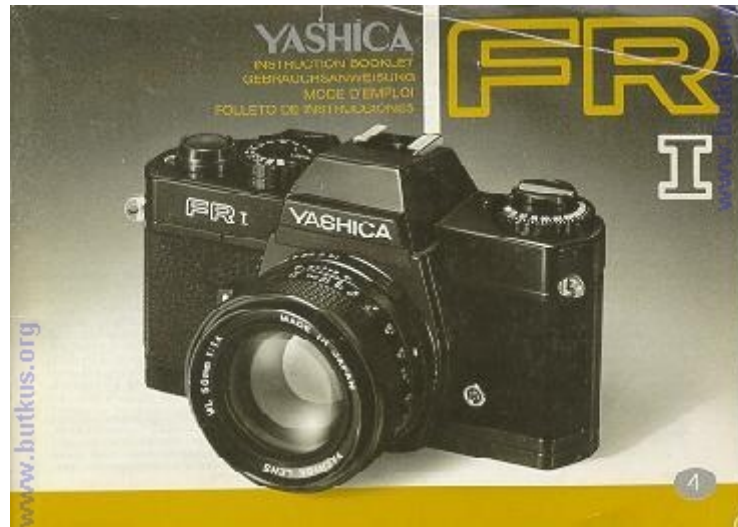

FEATURES OF THE FR 1

The Yashica FR I is highly precision 35 mm SLR camera incorporating the most sophisticated electronic systems that photo technology has to offer, It features a fully automatic aperture-preferred metering system with a silicon-photo-diode circuit for instantaneous exposure readouts when operated on AUTO. It also features manual override for those special situations when manual controls are handy, In addition, it maintains all of the advanced electronic features and systems advantages of the other cameras in the FR Series, including the Contax/Yashica mount for accepting a wide range of Yashica and Zeiss T. lenses.

The FR I's feather-touch electromagnetic shutter release makes possible blur-free pictures, and at the same time permits use of various remote control accessories such as cable switches and the Infrared Controller Set for wireless remote release. In addition, the electromagnetic release system also permits shutter release via the built in release button on the highly advanced RTF 540 electronic flash unit. And when the RTF 540 is used in conjunction with the Yashica Winder, the FR I is capable of sequential flash up to 2 frames per second.

Be sure to look into the countless other advantages of the FR I such as an interchangeable camera back to permit use with the Yashica Data Back, and hook-up with a variety of Contax and Yashica close-up equipment and other accessories.

FR is a licensed trademark of Cine Magnetics, Inc.

CONTENTS

Specifications	6	Automatic Exposure	44
Description of Parts	10	Exposure Compensation	52
How to Mount and Remove the Lens	14	Manual Operation	58
Battery Installation ,	16	Self-Timer	60
Battery Checking	18	Flash Exposure	64
Film Loading	20	Intentional Multiple Exposure	68
Film Rewind	28	Infrared Photography .,	70
Shutter Control Dial	30	"B" (Bulb) Exposure/Release Socket	72
Viewfinder	32	Depth-of-field Preview/Interchanging Camera Backs	74
Focusing	40	Depth of Field,	76
Shooting Posture	42	Ambient Temperature	78
		Camera Care	80
		Precautions	82

SPECIFICATIONS

Type: TTL metering fully automatic exposure 35 mm SLR camera.

Standard Lenses: Yashica lens DSB 50 mm f/1.9, Yashica Lens ML 50 mm f/1.7, Yashica Lens ML 50 mm f/1.4, Yashica Lens ML 55 mm f/1.2 (each with automatic diaphragm).

Lens Mount: Contax/Yashica mount

Negative Size: 24 x 36 mm

Shutter: Electronically controlled horizontal run focal plane shutter. Shutter speeds automatically varied between 4 sec. and 1/1000 sec. at AUTO setting; 1 - 1/1000 sec. manual shutter speed settings. Also bulb setting (B) and flash synchronization setting (^t) Direct X hot shoe and X sync terminal on camera body.

Self Timer: Built-in lever type; releases in approx. 7 sec.

Shutter Release: Feather-touch electromagnetic release; release socket on camera body for auxiliary shutter release.

Exposure Meter: TTL aperture-preferred fully automatic exposure control with manual override. Center weighted full aperture light metering via SPA cell.

Exposure Check Button: Push button type with slide lock. Lock releases on film advance lever return.

Exposure Range: Between EV 1 - 18 with f/1.4 standard lens using ASA 100 film.

Exposure Compensation: +2 EV

ASA Film Speed Settings: ASA 12 - 3200

Power Source: 6 V silver oxide battery (Eveready 544, Ucar 544, Mallory PX-28 or equivalent).

Viewfinder: Through-the-lens reflex viewfinder; shows a field of approx. 92% of the actual picture area with an image magnification of 0.87X. Aperture and shutter speeds visible in the viewfinder; pointer exposure indicators, manual control indicator.

Focusing Screen: Diagonal split-image center spot with microprism collar.

Film Advance: 140° single-stroke or multiples stroke film advance lever advances exposure frame, sets exposure counter, charges the electronic shutter and unlocks the exposure check button. Sequential film advance up to 2 fps with optional Yashica Winder unit.

Film Rewind: Via film rewind crank.

Back Cover: Standard back opens via film rewind crank; interchangeability with Data Back.

Other Features: Battery confirmation lamp illuminates exposure counter for viewing in the dark, lens release button, depth-of-field preview button, memo holder, multiple exposure capability.

Size and Weight: 142.5 x 87 x 50 mm 660 grams (body only)

DESCRIPTION OF PARTS



1. Exposure Counter/Battery Confirmation Lamp

2. Magnetic Release Button

11. ASA Film Speed Ring

12. Lens Release Button

3. Film Advance Lever

4. Shutter Control Dial

5. Direct X Contact

6. Accessory Shoe

7. Battery Checker Button

8. Exposure Compensation Dial

9. Film Rewind Knob

10. Film Rewind Crank

13 Self-Timer

14 Self-Timer Start Lever

15. Depth-of-Field Preview Button

16. Aperture Ring

17. Focusing Ring

18. X Sync Terminal

19. Film Rewind Stud

20. Film Chamber

21. Shutter Curtain

22. Viewfinder Eyepiece

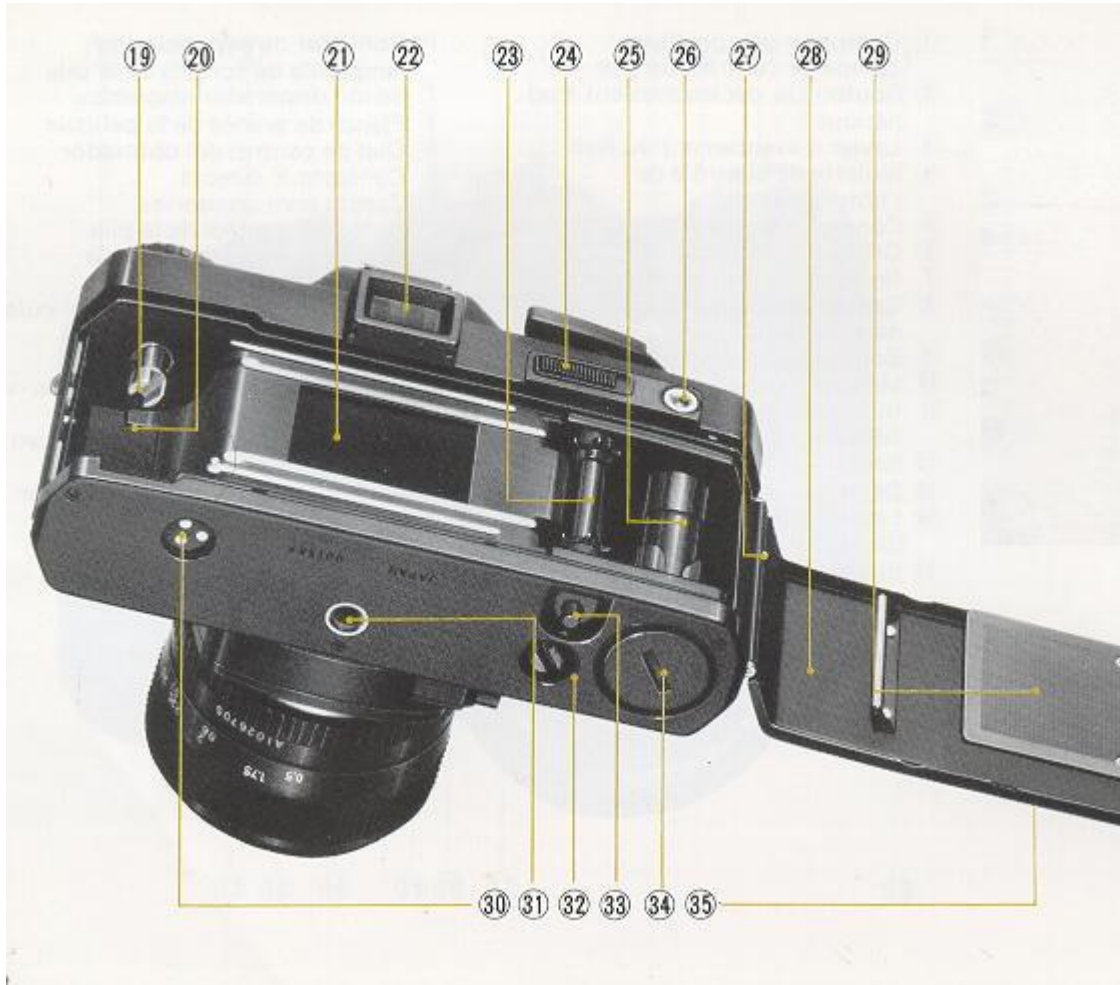

23. Sprocket Wheel

24. Exposure Check Button

25. Film Take-Up Spool

26. Release Socket

30) Motor Drive Coupling Terminal

31) Tripod Socket

32) Film Drive Coupling

33) Film Rewind Release Button

27. Camera Back Release Lug

28) Camera Back

29) Film Pressure Plate

34) Battery Compartment Cover

35) Memo Holder

HOW TO MOUNT AND REMOVE THE LENS

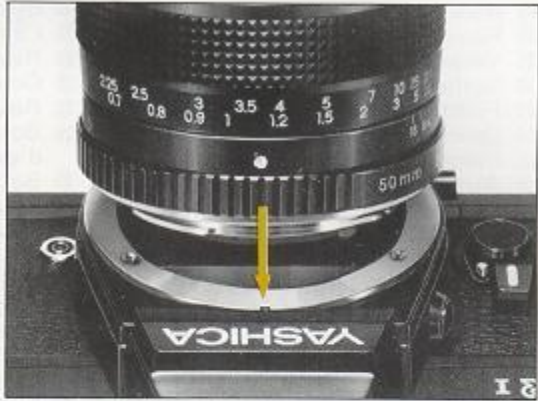

How to Mount the Lens

After removing the camera body cap, set the lens in the mount by matching the red dot on the lens barrel with that on the camera body. Then, while gripping the lens barrel firmly, give it a right turn until it self-locks with a click.

The method of mounting is the same with all lenses. Improper mounting will result in poor focus and/or exposure.

How to Remove the Lens

While keeping the lens release button depressed, turn the lens barrel all the way to the left and lift the lens straight out of the lens mount.

Avoid touching the linkage systems on the camera body and the lens.

Avoid direct sunlight when interchanging lenses.

To remove or reset the lens cap, press the knobs on both sides of the cap. The lens cap can be set even when a filter is in use.

BATTERY INSTALLATION

Make sure the battery is installed properly. Without the battery, the shutter system and the exposure control of Your Yashica FR I will not function.

1 Open the battery compartment cover on the camera base by turning it in the direction of the arrow with the edge of a coin.

2 Install the battery properly by matching its polarity with the diagram.

3 After ascertaining that the battery is installed properly, tighten the battery compartment cover securely.

Always use a 6 V silver oxide (Eveready 544, Ucar 544, Mallory PX-28 or equivalent) or 6 V alkaline (Eveready 537, Ucar 537 or equivalent) battery.

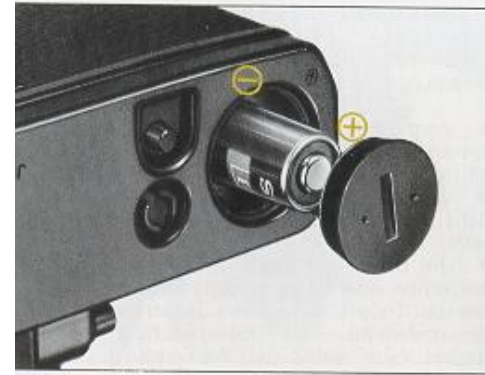

BATTERY CHECKING

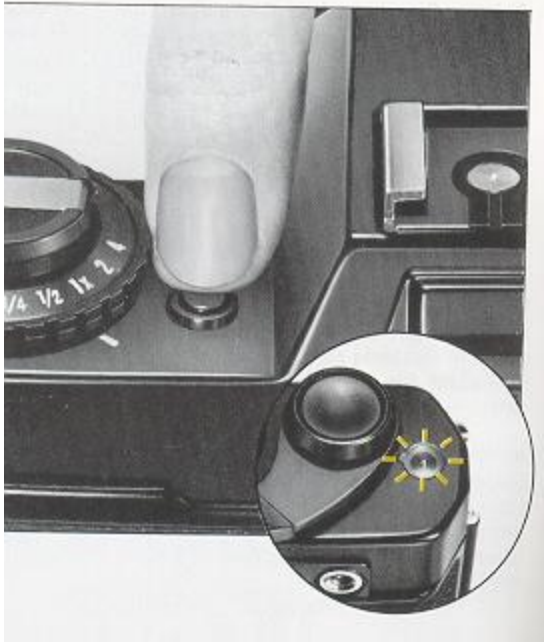

The shutter will not function when batteries are low. To prevent this, check the battery on the following occasions.

- * When inserting a new battery
- * When the camera has been left unused for some length of time.
- * When otherwise necessary.

To Check: Press the battery checker button. If the battery confirmation lamp illuminates the exposure counter window on the top right-hand side of the camera, battery power is sufficient. If the lamp fails to light, replace the battery.

(When using a new battery, check first to see that it has been inserted properly before replacing.)

The battery conformation lamp also functions to illuminate the exposure counter in poor lighting conditions.

FILM LOADING

Avoid direct sunlight when loading film. Always use a standard 135 film cassette (12, 20, 24 or 36 exposure load),

[1] Open the camera back by pulling the film rewind knob all the way out. As soon as the camera back is opened, the exposure counter will reset to 'S' (start) position.

[2] Install the cassette in the film chamber and push the film rewind knob back in. If it fails to return to its original position immediately, twist back and forth in either direction while pushing until it slips in place.

[3] Insert the tip of the film into one of the slots of the take up spool as illustrated. Avoid inserting the film too far.

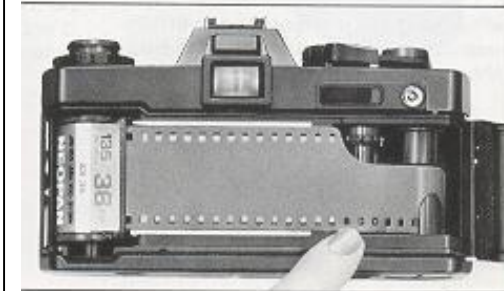
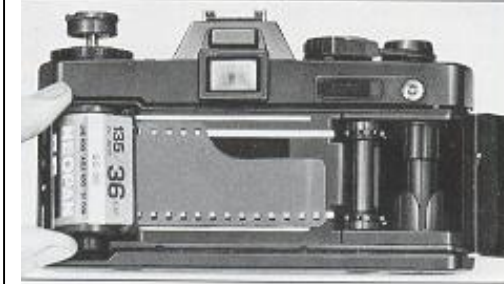

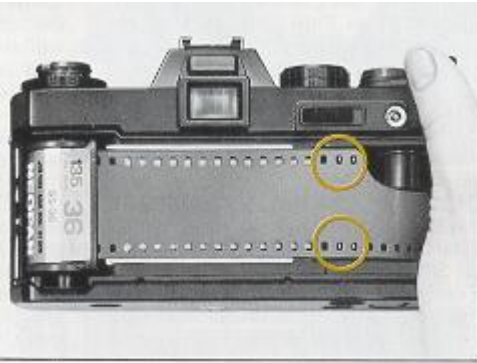

[4] Slide the film advance lever out past the ridge of the camera with your thumb and advance the film slightly until the sprocket teeth properly catch the perforations on the edges of the film.

Close the camera back and press until it locks in place.

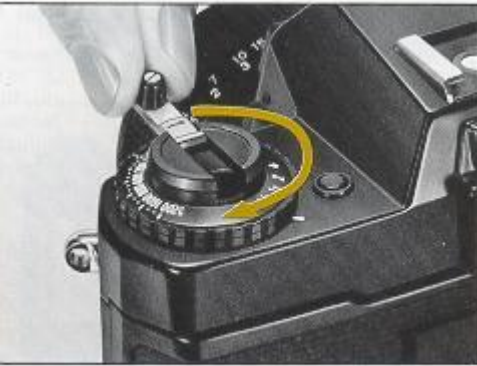

[5] Fold the film rewind crank out and turn gently in the direction of the arrow to take up film slack.

Before advancing the film, set the shutter control dial either to the "B" or to the flash synch (of) setting. Film wind-on may also be performed on AUTO provided it is done in bright light with the lens cap removed. Otherwise attempts to advance the film on AUTO for film wind-on will be hindered by excessively long exposure.

[6] Wind the film advance lever and trip the shutter alternately until the exposure counter reaches '1' (The film rewind knob will rotate counterclockwise when turning the film advance lever if the film is advancing properly.)

* Film may be advanced either by winding the film advance lever with one full turn or several short strokes. The electromagnetic release will not function, however, until the lever is completely wound.

* The film may also be wound on automatically by using the Yashica Winder unit which is sold as an optional accessory. Detailed instructions for use of the winder are given in the winder instruction booklet.

Exposure Counter

The exposure counter registers the number of exposed frames and is calibrated from 1 to 36 for frame indication, with the numbers 12, 20, 24 and 36 in red to indicate the last frame or respective film rolls. Counter automatically resets to S (start) when the camera back is opened.

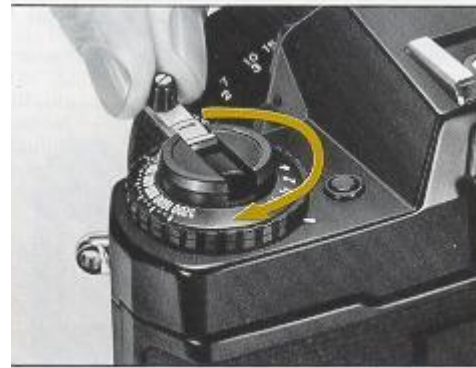
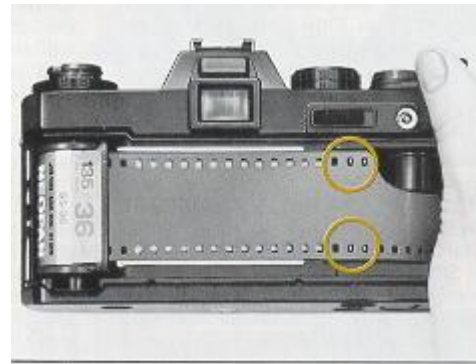



Memo Holder

The memo holder on the rear of the back cover is handy for exposure information. Insert the end of the film box to remind yourself what type of film you are using and how many exposures are on the roll.

Setting the film Speed

The ASA film speed rating denotes the degree of sensitivity of the film to light. After loading the camera, always make it a point to set the ASA film speed to assure proper exposure.

To Set: Lift the ASA film speed ring (surrounding the exposure compensation dial) and turn it until the figure corresponding with the speed rating of the film in use aligns with the orange index. Various ASA film speeds ratings are as follows.

FILM REWIND

When the exposure counter registers the number equivalent to the exposure load of the film in use, avoid advancing the film forcibly. If the perforations of the film tear or the film pulls away from the cassette, it will become impossible to rewind the film.

[1] Push in the film rewind release button on the camera base. It is unnecessary to keep this button depressed all the while during film rewind.

[2] Fold out the film rewind crank-handle and turn it in the direction of the arrow. When the crank-handle is turned, the take-up spool will rotate with an audible signal, indicating that the film is being rewound properly. The crank-handle will rotate freely when the film is rewound completely into its cassette.

* When the film fails to advance, push the film rewind release button and rewind.

* Make sure the exposed film is rewound into the film cassette before opening the camera back.

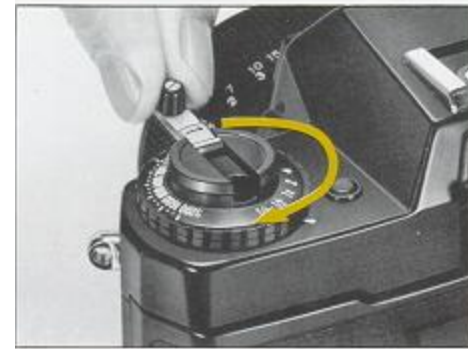
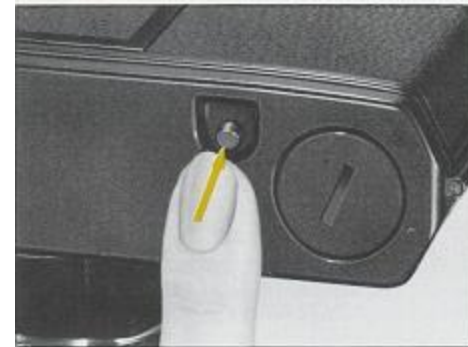

SHUTTER CONTROL DIALS



For normal shooting purposes, shutter speeds are automatically controlled with the FR I when the shutter control dial set to AUTO. Including AUTO, the dial has the following settings.

Auto For automatic shutter speed control. Autoexposure control with the FR I is aperture-preferred: when you preset the f-number, the camera automatically selects the correct shutter speed. The speed selected by the camera is indicated in the viewfinder by pointer index. 1-1/1000 .

Shutter speed settings for manual control. "M" (manual) indicator will appear in viewfinder when the dial is set to the manual shutter speeds (lighting bolt) flash synchronization . . . Set the dial to this setting to synchronize the camera for use in conjunction with an electronic flash unit. (See page 64.) (B)

The "B" (bulb) setting is used for exposures in excess of 1 sec. (See page 72.)

VIEWFINDER

1. Microprism Collar
2. Split-image
3. Aperture Scale
4. Aperture Pointer
5. Shutter Speed Pointer
6. Shutter Speed Scale
7. Overexposure Zone
8. Long Exposure Zone
9. Manual Indicator

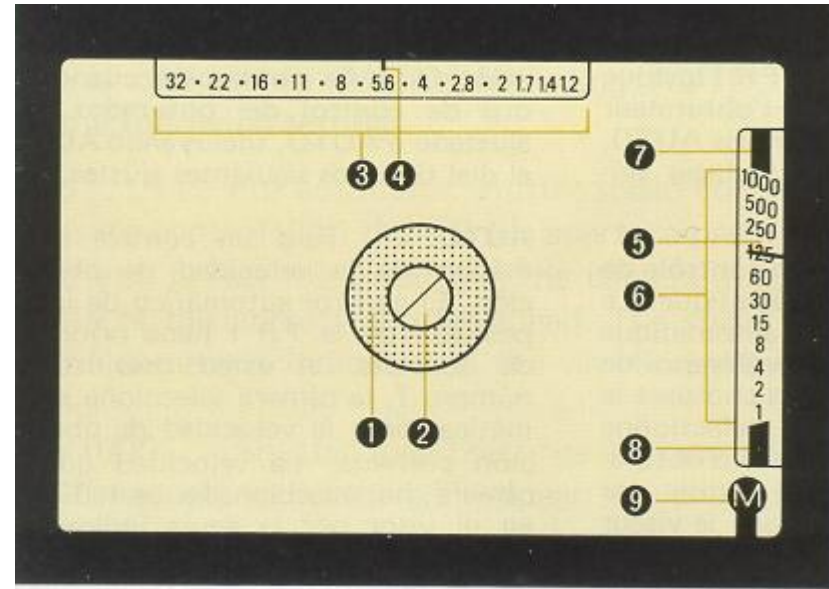

The viewfinder of your Yashica FR I always gives readings at full aperture for bright and easy focusing. It also gives all of the necessary exposure information.

Viewfinder Field

The viewfinder shows approximately 92% of the actual picture area in its field. Whatever you see through the finder will be reproduced on the film without fear of head cropping, regardless of which lens you use.

Split-image Microprism

This camera features a dual focusing spot for easy focusing which consist of a diagonal split-image center with a microprism collar. (See page 40 for focusing details.)

Aperture Scale

The figures along the top edge of the viewfinder constitute the aperture scale. When the aperture ring is rotated, the pointer moves to indicate the indexed f-number. With lenses slower than f/5.6, and when accessories are employed which do not feature automatic diaphragm functions, the aperture pointer does not function and remains stationary at f/1.4. This does not interfere with the camera's automatic exposure controls, however, and shutter speed readings are given as normal.

Shutter Speed Pointer

When the exposure check button is depressed, the pointer at the right of the viewfinder will indicate the shutter speed automatically set by the camera when operated on AUTO. When using manual settings, it gives the recommended shutter speed. (See page 46.)

Overexposure Zone

When the shutter speed pointer climbs to this zone, the picture will be over-exposed. For adjustment, refer to page 46. Long Exposure Zone When the shutter speed pointer is in this zone, light will be sufficient for up to a 4 sec. exposure. (See page 46.)

Manual Indicator

The "M" (manual) indicator appears in the viewfinder when the shutter control dial is set off of AUTO.

FOCUSING



Turn the focusing ring while observing the subject in the split-image center spot, microprism collar or matte area of the viewfinder.

Split-image Center Spot Precise focus is secured when the images in the diagonal split-image center spot are brought into alignment.

Microprism Collar and Matte Area When the multiple glitter disappears in the microprism collar or when the image appears clear and sharp in the matte area, precise focus is secured.

* The method of focusing remains the same regardless of whatever lens or accessory is in use.

Eyesight Adjustment To permit adjustment of the viewfinder to the eyesight of the individual, eight types of diopter lenses (-5 to +3 diopters) are available.

SHOOTING PICTURES

To obtain good results, it is important that the camera be held steady. Erratic movement of the camera at the critical moment of exposure constitutes the most common cause of poor (blurred) photographic results. Before attempting to take your first series of photographs, familiarize yourself with all functional controls. As illustrated, the camera can be held in either horizontal or vertical posture, depending on your photographic requirement. In either case, support your camera firmly with your left hand, with your left elbow held close against your body. Avoid gripping the camera body too firmly with your right hand and press the magnetic release button gently.

* For extra steady support, the trunk of a tree or wall of a building or other structure can be used most effectively.

* When using a telephoto lens or when making exposure at a slow shutter speed, the use of a tripod is recommended.



AUTOMATIC EXPOSURE

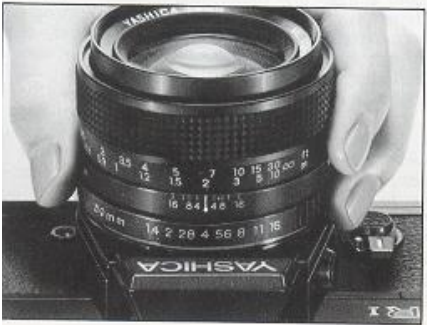
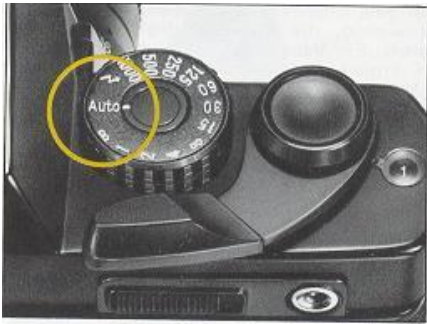

Your Yashica FR I features fully automatic through-the-lens electronic exposure control. By simply presetting the film speed and lens aperture, its exposure control system varies the shutter speed continuously according to subject brightness to assure correct exposure under any light conditions.

[1] Turn the shutter control dial to AUTO, and set the exposure compensation dial to 1X.

[2] Preselect the lens aperture by setting the required f-number to correspond with the index. The following table serves as a guide for selecting the approximate f-number under different lighting conditions when using ASA 100 film.

Light Condition	F-stop
Outdoors under bright sunlight	16, 11, 8
Outdoors (overcast)	5.6, 4, 2.8
Indoors or night photography	2, 1.4

[3] While sighting through the viewfinder, press the exposure check button. If exposure is adequate--between the 1/1000 and 1 sec. shutter speeds--focus, compose the picture and release the shutter.

* For shutter speeds below 1/30 sec. pictures will blur unless utmost precaution is taken to prevent camera shake. This can be avoided by resetting the aperture ring to a wider lens opening which will give a faster shutter speed.

* When shooting at a slow shutter speed is necessary, brace the camera firmly or use a tripod.

* When the pointer is in the overexposure zone, correction can be made by stopping the lens aperture down to give less exposure (i.e., f/8 to f/11 or f/16, etc.). A neutral density filter may also be employed for exposure adjustment.

* When the pointer is in the long exposure zone, unless extend exposure is desired, open the lens aperture (f/8 to f/5.6 or f/2.8, etc.) to obtain a faster shutter speed. Long exposures (up to 4 seconds) may be made in this zone if a tripod is used.



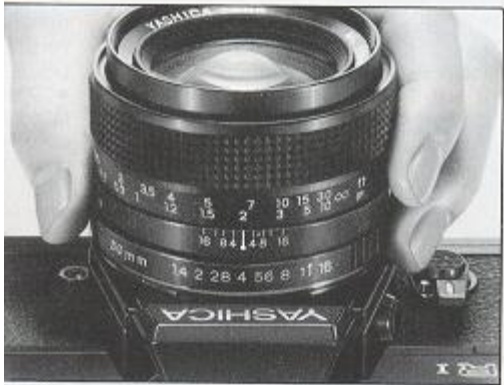

As the FR I uses an aperture-preferred automatic exposure control system, shutter speeds may be varied by adjusting the aperture ring. Check, beforehand, that the shutter control dial is set to AUTO and the exposure compensation dial to 1X.

[1] Depress the exposure check button and check the shutter speed in the viewfinder.

[2] With the exposure check button engaged, turn the aperture ring until the pointer aligns with the desired shutter speed.

The following table serves as a guide for preselecting shutter speeds:

Subject	Shutter Speed
Fast-moving objects	1 /1000, 1/500 sec.
Landscape and general outdoor photography	1/250 1/125 or 1/60 sec
Indoor or night photography	1/30 sec. or slower

Exposure Check Button

In addition to providing instantaneous exposure readings, the exposure check button may also be locked to give longer readings. To lock the check button, pull the film advance lever out past the edge of the camera to the point where it catches (see illustration) and slide the check button all the way to the right until it locks. To unlock the button, push the film advance lever all the way in toward the shutter control dial.

* Once the button has been locked, the film may be wound without disengaging the lock mechanism.

* Always make it a point to unlock the button after setting exposure to avoid excessive battery drain.

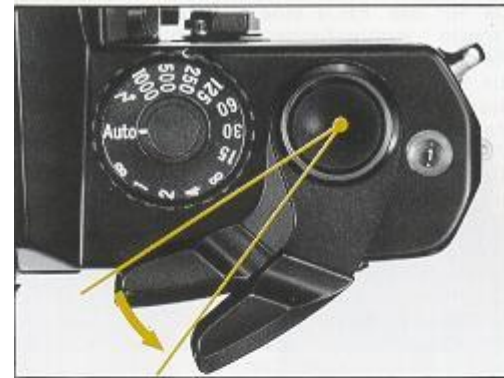

EXPOSURE COMPENSATION



For normal shooting, the exposure compensation dial should be set to 1 X. When shooting backlit or spotlighted subjects, or when special effects are desired, exposure compensation is required.

The exposure compensation scale has four click stop settings (2, 4, 1/2 and 1/4) in addition to 1 X. It can also be used at in-between settings. Operate the dial by rotating it until the required compensation factor aligns with the black index mark. Always remember to return the dial to 1 X when exposure compensation is no longer required.

For Backlit Subjects

When shooting against the light or when photographing subjects against a window or bright snow scene, the main subject will be underexposed. To compensate for this and bring out the details of your subject, set the exposure compensation dial to either "2" or "4".

The "2" setting doubles the amount of light reaching the film:

Thus a shutter speed of 1/250 sec. will automatically lower to 1/125.

The "4" setting quadruples the amount of light reaching the film:

Thus a shutter speed of 1/250 sec. will automatically lower to 1/60 sec.

The top photo was made employing 4X exposure compensation. The bottom photo was made without exposure compensation.





Spotlighted Subjects To prevent overexposure of the main subject resulting from the intensity of spotlighting, it is necessary to reduce the amount of light reaching the film by setting the exposure compensation dial to 1/2 or 1/4.

The "1/2" setting reduces the amount of light reaching the film by one-half: Thus a shutter speed of 1/250 is automatically increased to 1/500 sec.

The "1/4" setting reduces the amount of light reaching the film by one-fourth: Thus a shutter speed setting of 1/250 is automatically increased to 1/1 000 sec.

The top photo was made with 1/4 exposure compensation; exposure compensation was not employed for the bottom photo.

MANUAL OPERATION

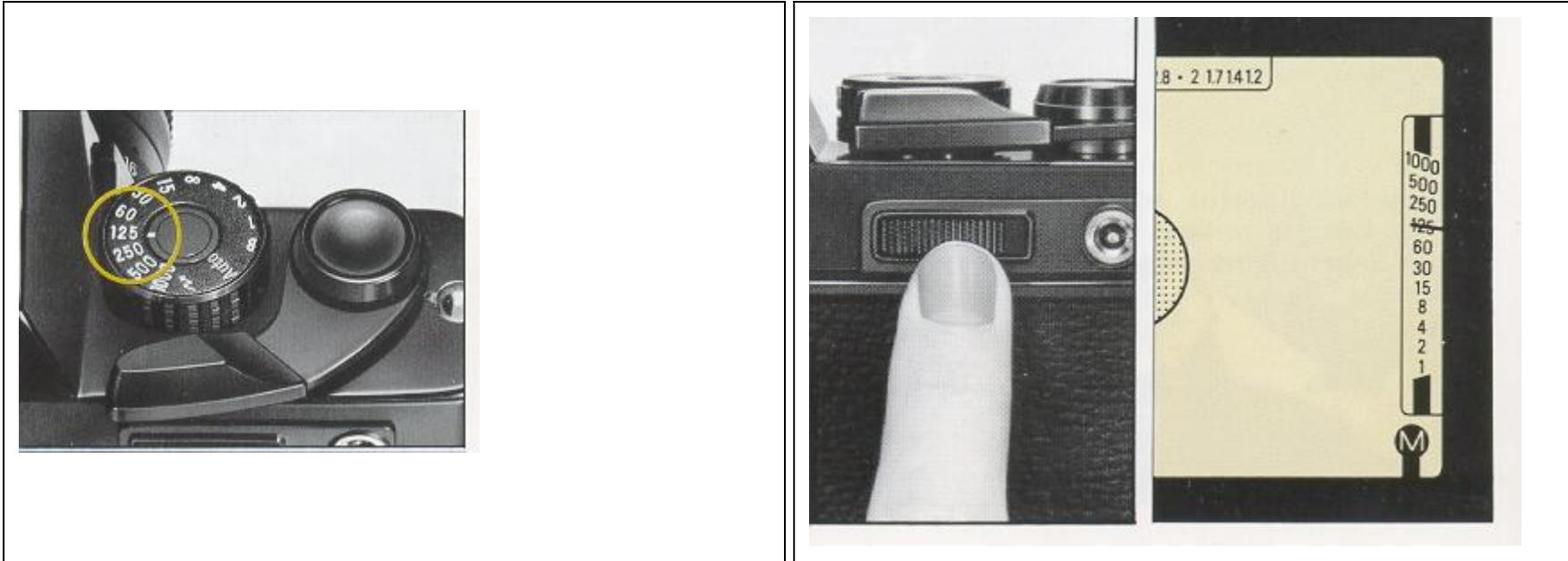

The Yashica FR I can also be used on manual for those special occasions when manual control is desired, for flash synchronization and for long exposures at the B setting. When the camera is operated on manual, the shutter will not function at in-between shutter speed settings.

[1] Set the shutter control dial to the desired manual setting. The "M" (manual) indicator will now appear in the lower right-hand portion of the viewfinder.

[2] Press the exposure check button and then rotate the aperture ring until the pointer indicator aligns with the pre selected shutter speed.

* The correct exposure can also be obtained on manual by pre selecting the lens aperture. In this instance, pre select the f-number and press the exposure check button. Then set the shutter control dial to the reading given by the shutter speed pointer.

SELF TIMER



When you wish to include yourself in the picture, mount the camera on a tripod and trip the shutter with the aid of the self-timer.

[1] Advance the film and secure precise focus.

[2] Shift the self-timer lever on the front-face of the camera body all the way in the direction of the arrow (see illustration).

[3] Push the self-timer start lever in the direction of the arrow to activate the self-timer. The shutter will be tripped after a delay of approximately 7 seconds.

* When using the self timer for shutter release, slide the rubber eyecup over the viewfinder as illustrated to prevent exposure inaccuracy due to excess light entering through the viewfinder. Then, fold the rubber rim of the eyecup down over the finder.

* If the film advance is incomplete, the self-timer will be activated through manipulation of the self-timer start lever but it will not trip the shutter. In such a case, manipulate the film advance lever to complete the film wind.

* If after activating the self-timer you wish to suspend the self-timer exposure, simply reset the self-timer start lever manually to its original position.

* The magnetic release button will function normally even when the self-timer is charged.

FLASH EXPOSURE

Electronic flash units and flash bulbs greatly aid in making correct exposures with night and indoor photography, and are also useful for providing fill-in light for outdoor shooting.

The FR I uses X flash synchronization.

[1] Slide the flash unit firmly into the camera's accessory shoe. With flash unit's requiring PC cord synchronization, plug the PC cord into the X sync terminal on the camera body.

[2] Set the camera's shutter control dial to the flash synchronization (of setting).



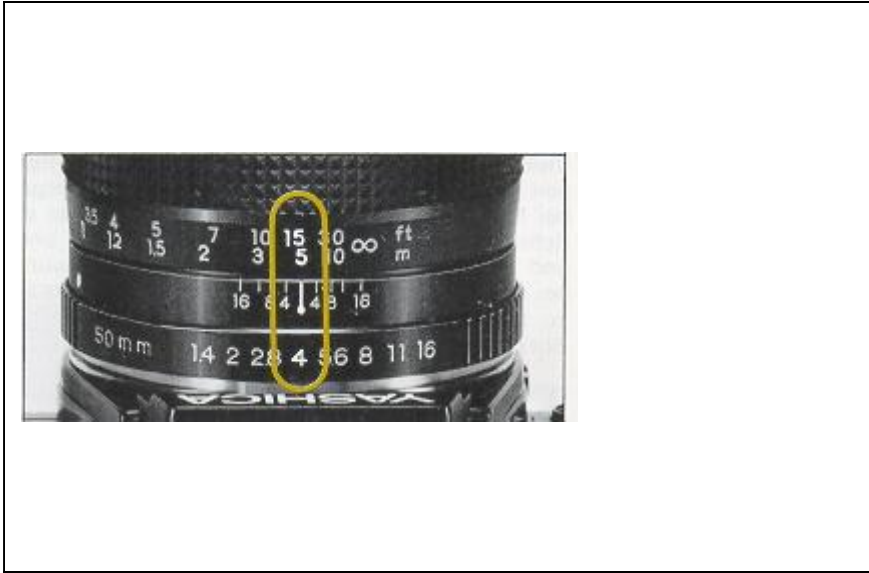

[3] Focus and then read off the camera-to-subject distance on the distance scale of the lens. The correct f-number in correspondence with the subject distance may be computed by dividing the flash unit's guide number by the subject distance. For example, at a distance of 5 meters with a guide number of 20 (ASA 100 in meters), the correct f-number is f/4:

$$\text{GN } 20 / 5 \text{ (distance in meters)} = f/4$$

* When the guide number is given in feet, see that the flash-to-subject distance is converted to feet.

* The Contax RTF 540 flash unit with a built-in electromagnetic shutter release can also be employed with the FR I. For operating details, refer to the RTF 540 instruction manual.

* When employing flash bulbs, use the synchronization speeds given in the following table.

Shutter Speed	1/15	1/8	1/4	1/2	1
Flash bulb	O	O	O	O	O

INTENTIONAL MULTIPLE EXPOSURE

Your FR I is capable of producing unique and interesting multiple exposures on a single frame by employing a special technique.

[1] Take the first frame in the normal manner.

[2] Then depress the film rewind release button and give the film advance lever a full wind. This charges the electronic shutter system without advancing the film.

[3] Press the magnetic release button to make the second exposure. Repeat the same steps for additional exposures. (Keep in mind that the exposure counter will continue to advance each time you make a multiple exposure; thus, you will have more frames left at the end of the roll than the registered count.)

* As a general rule, better results with multiple exposures are obtained by superimposing lighter subjects over darker ones. Multiple exposures of equally bright subjects do not come out too well.

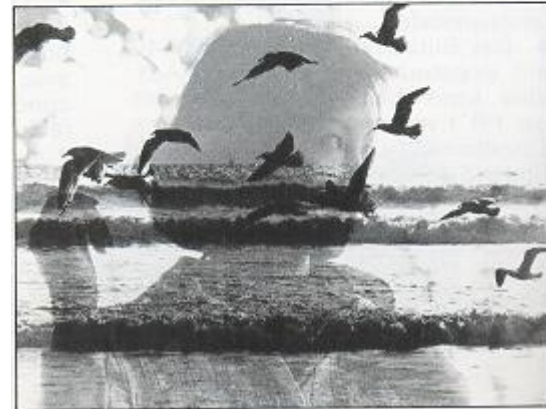
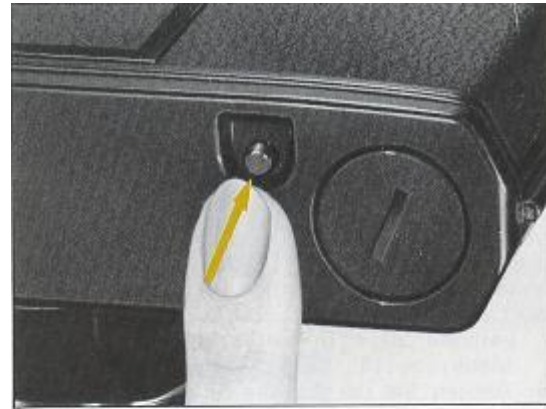

INFRARED PHOTOGRAPHY

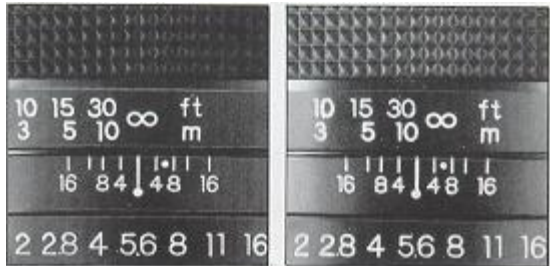

In case of infrared ray photography using the infrared ray film in combination with the red filter, focus must be secured in the normal manner and then compensated accordingly in order to obtain sharp images. The Yashica ML and Zeiss T* lenses feature R index permitting ready compensation of focus.

First, secure focus in the normal manner without using the filter. Then, read off the subject distance and align it with the R index. After making this compensation, mount the filter over the lens.

Always use the red filter when attempting infrared ray photography.

For correct exposure setting, refer to the instructions accompanying the infrared ray film.

<If you wish to go IR, go digital>

"B" (Bulb) EXPOSURE

"B" (Bulb) Exposure

For exposures longer than one second, set the shutter speed control dial at the "B" setting. As the shutter will remain open for as long as the electromagnetic release button is depressed, always use a tripod to prevent camera movement. Use of the Cable Switch (sold as an optional accessory) is also convenient when shooting at the "B" setting.

Release Socket

The electromagnetic shutter system of the FR I makes possible use of the camera with various remote release systems and accessories. For such purposes, a release socket is provided to the right of the exposure check button to serve as an auxiliary release and accessory input terminal. The release socket receives the electrical signals for accessories such as the Infrared Controller Set, assorted Cable Switches, the RTF540 flash unit's integral release system and the Data Back recorder among others.



DEPTH OF FIELD PREVIEW / INTERCHANGEABLE BACKS

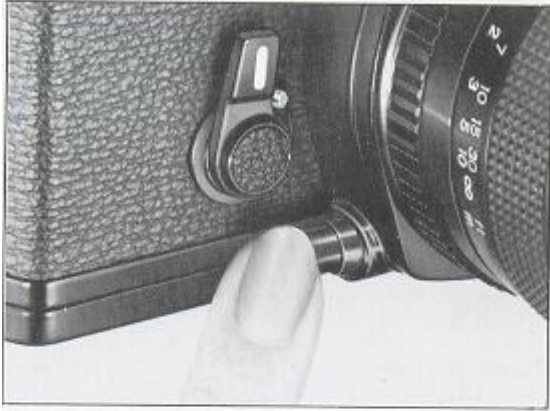

Depth-of-Field Preview

With any one of the Yashica ML or Zeiss T* your Yashica FR I always provides full aperture viewing and focusing. To preview the depth of field, therefore, push in the depth-of-field preview button. The lens diaphragm will close down to the preset aperture as long as the button is kept depressed.

To prevent exposure inaccuracy, keep your finger off this button except when previewing the depth of field.

Interchanging Camera Backs

To interchange the camera back, press the camera back release lug and remove as illustrated.

The standard camera back can be interchanged with the exclusive data back available as an optional accessory.

DEPTH OF FIELD

When a lens is focused on a given subject, objects in the foreground and background will appear acceptably sharp in the picture. The extent to which all objects will be reproduced acceptably sharp in the picture is called the depth of field.



In the photo taken at $f/1.4$, the foreground and background objects appear blurred.

The depth-of-field scale on the lens barrel will show the extent of the depth of field at different aperture settings. In case the standard 50 mm lens is stopped down to $f/16$ and focused at 2 meters, this scale will indicate that all objects within the range of about 1.5 and 3 meters will appear acceptably sharp in the picture.

With a specific lens, the depth of field varies according to the following;

- [1] It increases as you stop down the lens.
- [2] It is more extensive in the background than in the foreground.
- [3] It is more extensive as you focus on a distant subject.

AMBIENT TEMPERATURE

Your Yashica FR I has been tested to function faithfully in ambient temperature ranging from + 45° to--5° C. In extremely low ambient temperature, however, give utmost precaution to the following matters:

- * A battery which may function properly in normal ambient temperature may not provide the required performance in extremely low temperature. If the battery confirmation lamp fails to come on, replace the battery with a new one or use the battery adapter set available as an optional accessory.
- * Avoid exposing your camera to excessive temperature fluctuation.

When your camera is brought into a warm room suddenly after exposing it to cold outdoor temperature or vice versa, small droplets of water may accumulate on the internal mechanism. If left in this state corrosion may set in, causing serious malfunctions. Protect your camera from excessive temperature fluctuation as much as possible.



CAMERA CARE

- * Do not expose your camera to excessive heat. Never leave it in direct sunlight or in the glove compartment, trunk or on the rear seat shelf of your car. Exposure to excessive heat may adversely affect the film emulsion, battery and/or camera systems and cause exposure inaccuracy. If it is accidentally exposed to heat, leave the camera to cool to normal temperature before attempting to use it.
- * Knocks and jolts, as well as exposure to humidity and sea breeze are counted among the common causes of malfunction. To obtain maximum service, take good care of your camera and avoid rough handling.
- * Do not keep the shutter charged when your camera is to be left unused over any great length of time. If possible, take the battery out of its compartment.
- * Never expose your camera to sudden changes in temperature, because the electrical contacts may corrode, thus causing malfunction due to poor electrical contact.

Precautions

- * Before installing the battery in the battery compartment, wipe both ends with a clean, dry cloth. Oily smears on the battery ends may cause poor contact.
- * In case your camera is to be left unused over a great length of time, take out the battery from its compartment.
- * When going out on a long trip, take along a couple of spare batteries.
- * To avoid hazards, do not attempt to dismantle the battery or to throw it into open fire.

